

# Translation of the Original Operating Instructions

## MAB 825 / MAB 845

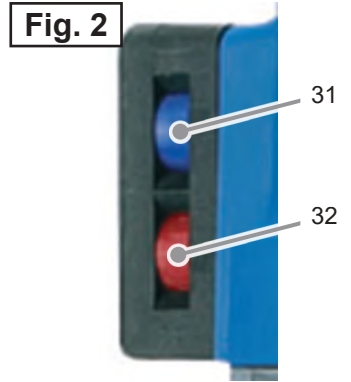

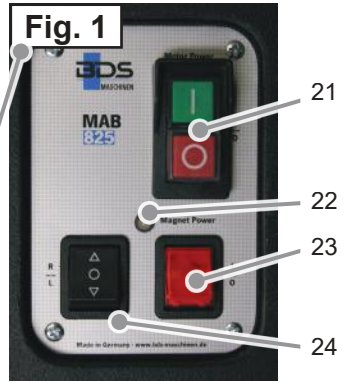
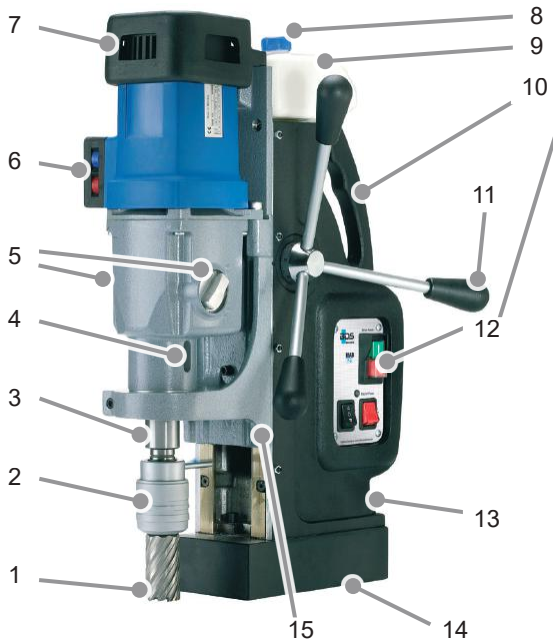

**Table of Contents**

**General instructions . . . . .3**  
**Safety . . . . .5**  
**Components / delivery contents . . . . .10**  
**Before using for the first time . . . . .11**  
**Preparation. . . . .11**  
**Using. . . . .16**  
**Eliminating blockages. . . . .20**  
**Cleaning/maintenance . . . . .21**  
**Storage . . . . .22**  
**Troubleshooting . . . . .22**  
**Technical data . . . . .23**  
**EC Declaration of Conformity . . . . .24**

**General instructions**

**Copyright**

This document is subject to copyright. Duplication or reprinting, even in part as well as reproduction of the illustrations, even if modified, is only permitted with written consent of the manufacturer.

**Liability disclaimer**

All technical information, data and instructions contained these operating instructions for startup, operation and care correspond to the latest requirements at the time of printing.

The manufacturer assumes no liability for damage or injury resulting from failure to observe the operating instructions, use for other than the intended purpose, unprofessional repairs, unauthorised modifications or use of non-approved spare parts and accessories, tools and lubricants.

**Instructions on disposal**

 The packaging materials used can be recycled. When no longer required, dispose of the packing materials according to local environmental regulations.

 This product may not be disposed of in the European Union via the normal household refuse. Dispose of the device via communal collection points.

 The lubricant used can contain substances dangerous to the environment. Dispose of the lubricant according to local regulations. Observe the disposal instructions from the lubricant manufacturer.

---

Dear Customer,  
 Before using the machine, please read the operating instructions contained in these operating instructions on startup, safety, intended use as well as cleaning and care.  
 The links and illustrations in these instructions refer to the illustrations on the inside of the cover.  
 Keep these operating instructions for later use and pass them onto the next owner of the machine.

## Safety warning structure

The following warnings are used in these operating instructions:

### **DANGER**

**A warning of this category indicates an impending dangerous situation.**

If the dangerous situation is not avoided, it may lead to serious injury or even death.

- ▶ Follow the instructions in this warning to avoid possible danger of serious injury or even death.

### **WARNING**

**A warning of this category indicates a potentially dangerous situation.**

If the dangerous situation is not avoided, it may lead to serious injury or even death.

- ▶ Follow the instructions in this warning to avoid the danger of serious injury to persons.

### **ATTENTION**

**A warning of this category indicates potential danger to property.**

If the situation is not avoided, it may lead to material damage.

- ▶ Follow the instructions in this warning to avoid material damage.

### **NOTE**

- ▶ A note indicates additional information that simplifies the use of the machine.

## Intended use

The machine is intended solely for drilling operations in magnetic and non-magnetic metals, and for cutting threads, counter-sinking and reaming within the limits specified in the technical data.

Any use other than previously stated is considered as improper use.

### **WARNING**

**Danger resulting from improper use!**

If not used for its intended purpose and/or used in any other way, the machine may be or become a source of danger.

- ▶ Use the machine only for its intended purpose.
- ▶ Observe the procedures described in these operating instructions.

No claims of any kind will be accepted for damage resulting from use of the system for other than its intended purpose.

The risk must be borne solely by the user.

### **NOTE**

- ▶ If used commercially, pay attention to compliance with the accident prevention and occupational safety regulations.

## Safety

### NOTE

When using electrical tools, the following fundamental precautions must be taken to protect against electric shock and the risk of injury and fire!

### Fundamental safety instructions

- Do not use the machine in potentially flammable or explosive environments.
- Persons, who are unable to safely operate the machine due to their physical, mental or motor abilities, may only use the machine under the supervision or instruction of a person responsible.
- Persons with heart pacemakers or other medical implants must not use this machine.
- Children are not permitted to use the machine.
- Inspect the machine for visible signs of damage before use. Do not operate a damaged machine.
- Before beginning work, check the condition of the safety chain and the function of the switches on the machine.
- Repairs to the connecting cable may only be performed by a qualified electrician.
- Repairs to the machine may only be performed by an authorised specialist workshop or factory customer service. Unqualified repairs can lead to considerable danger for the user.
- Repairs to the machine during the guarantee period may only be performed by a customer service authorised by the manufacturer, otherwise the guarantee is invalid.
- Defective parts may only be replaced with original spare parts. Only these parts ensure that the safety requirements are met.
- Do not leave the machine unsupervised during operation.
- Store the machine in a dry, temperate location out of the reach of children.
- Do not allow the machine to stand outside and do not expose to moisture.
- Make sure that your work area is sufficiently lit (>300 Lux).
- Do not use low-power machines for heavy working.
- Pay attention to cleanliness at the workplace.
- Keep the machine clean, dry and free of oil and grease.
- Follow the instructions on lubricating and cooling the tool.

## Danger from electric current!

### DANGER

**Danger to life from electric current!**  
**Contact with live wires or components can lead to serious injury or even death!**

Observe the following safety precautions to avoid any danger from electric current:

- ▶ Do not open the housing of the machine. Risk of electric shock from touching live connections.
- ▶ Never immerse the machine or mains plug in water or other liquids.
- ▶ Only use extension cables or cable drums with a cable cross-section of at least 1.5 mm<sup>2</sup>.
- ▶ Only use extension cables that are approved for the location of use.
- ▶ Check the condition of the extension cable regularly and replace if damaged.
- ▶ Avoid bodily contact with grounded parts (e.g., pipes, radiators, steel girders) to reduce the risk of electric shock in the event of a defect.
- ▶ When using the machine outside or in a humid environment, an RCD (residual circuit device) must be used.

## Risk of injury!

### WARNING

**Risk of injury from engine starting unintentionally!**

Pay attention to the following safety notes to avoid danger from motor starting unintentionally:

For safe stopping of the motor:

- ▶ Press the red button (O) of the motor switch (21).
- ▶ Switch off the machine with the ON/OFF switch (main switch) (23).
- ▶ Disconnect the voltage supply (pull out the mains plug).

### WARNING

**Improper handling of the machine increases the risk of injury!**

Pay attention to the following safety instructions in order not to injure others or yourself:

- ▶ Operate the machine only with the protective equipment specified in these instructions (see section "**Personal protective equipment**").
- ▶ **Do not** wear protective gloves when the machine is running. A glove can be caught by the drilling machine and torn off the hand. Risk of losing one or more fingers.
- ▶ Remove loose jewellery before beginning work.
- ▶ Wear a hair net if you have long hair.

**⚠ WARNING**

- ▶ Always switch off the machine before changing tools, performing maintenance or cleaning. Wait until the machine has come to a complete standstill.
- ▶ Always remove the plug from the mains socket before changing tools, cleaning or performing maintenance work in order to avoid unintentional starting of the machine.
- ▶ Do not put your hand into the machine while it is in operation. Remove swarf only when the machine is at a standstill. Wear protective gloves when removing swarf.
- ▶ When working on scaffolding, the operator must be secured with a safety belt as the machine can oscillate dangerously in the event of interruption to the power supply.
- ▶ Check for secure clamping of the electromagnets on the substrate before every use (see section ***“Preparation”***).
- ▶ Secure the machine with the safety chain (D) supplied when working in an inclined or vertical position and during overhead work. The machine could fall down if the magnet is loosened or the power fails.
- ▶ Check that the tool is tightened securely before using (see section ***“Inserting the tool”***).
- ▶ Do not allow the connecting cable to hang over edges (trip effect).

**Preventing damage****ATTENTION****Potential damage to property if the machine is improperly used!**

Observe the following instructions to avoid damage to property:

- ▶ Before connecting the machine, compare the connection data (voltage and frequency) on the rating plate with those of your mains power supply. The data must correspond in order to avoid damage to the machine.
- ▶ Always use the handle to carry the machine and not the connecting cable.
- ▶ Do not pull the mains cable to remove the plug from the mains socket.

## ATTENTION

- ▶ Do not crush the connecting cable.
- ▶ Do not subject the connecting cable to heat or chemical liquids.
- ▶ Do not pull the connecting cable across sharp edges or hot surfaces.
- ▶ Lay the connecting cable in such a way that it cannot be caught and wound up in the rotating part of the machine.

## Safety equipment

### Restart protection

#### NOTE

- ▶ The machine stops automatically when the magnetic clamp is switched off or if the power supply is interrupted.

In order to prevent the machine from starting unexpectedly after switching on the magnetic clamp again or after reconnection following interruption to the power supply ("restart protection"), the machine must be switched on using the ON/OFF switch.

### Magnet indicator

The magnet indicator (22) provides visual indication of the magnetic clamping force.

- Magnet indicator (22) lights up **GREEN**: The magnetic clamping force satisfies the minimum requirements. Processing can take place.
- Magnet indicator (22) lights up **RED**: Insufficient magnetic clamping force. Do not process with the machine. This can be the case if the material is too thin, the surface is uneven or if coated with paint, scale or zinc.

### Overheat protection

The machine is also protected against overheating. If the machine becomes too hot, it switches off automatically.

Perform the following steps before continuing to work with the machine:

- Remove any blockages that may have occurred.  
(see section "**Eliminating blockages**")
- Allow the machine to run at idle for approx. 2 minutes.

The machine is then ready for operation again.





**Slip clutch**

If the drill blocks, the gearbox is protected by a slip clutch.



**Symbols on the machine**

The symbols on the machine have the following meaning:

Symbol	Meaning
	Electric shock hazard!
	Read the operating instructions before beginning work!
	Wear protective goggles and ear protection!

**Personal protective equipment**

Wear the following protective equipment at all times when operating the machine:

Symbol	Meaning
	Close-fitting work protection clothing with a low tear strength
	Goggles for protecting eyes against flying parts and liquids and ear protection in areas with noise emission >80 dB(A)
	Safety shoes for protecting feet against falling objects.

Also wear the following protective equipment during special work:

Symbol	Meaning
	Helmet for protecting your head against falling objects
	Wear a harness where there is a danger of falling.
	Gloves for protection against injuries

## Components / delivery contents

### Machine overview

1	Core drill (not supplied as standard)
2	Tool mounting KEYLESS quick-change drill chuck system
3	MK3 spindle taper
4	Opening for ejector pin
5	4-speed gearbox with selector
6	Speed and torque control (see fig. 2)
7	Engine drive
8	Filler neck for cutting oil
9	Cutting oil tank
10	Handle
11	Hand lever
12	Control panel (see fig. 1)
13	Rotating mechanism (MAB 845 only)
14	Magnetic foot
15	Machine slide and guide

### Operating panel

(see fig. 1)

21	Motor ON/OFF switch
22	Magnet indicator (Magnet Power)
23	Magnet ON/OFF switch (main switch)
24	Direction of rotation switch

(see fig. 2)

31	Speed setting
32	Torque setting

### Delivery contents

	MAB 825 / MAB 845 core drilling machine
A	KEYLESS quick-change drill chuck system
B	ZAK 075 ejector pin
C	ZAK 100 ejector pin
D	ZAK 120 ejector pin
e)	Safety chain
S	MK3 ejector pin
G	MK3 industrial arbor/32 mm Weldon
H	Hexagonal offset screwdriver, size SW6
	Transport case (not illustrated)
	Operating instructions/guarantee card (not illustrated)

## Before using for the first time

### Transport inspection

As standard, the machine is supplied with the components indicated in the **“Delivery contents”** section.

#### NOTE

- ▶ Check for visible signs of damage or missing items on delivery. Report an incomplete or damaged delivery to your dealer/supplier immediately.

## Preparation

This section contains important instructions on the required preparation before beginning any work.

### Additional safety measures for certain work

Additional safety precautions must be taken for the following operations with the machine:

#### Non-horizontal work position

#### WARNING

##### **Risk of injury from a falling machine.**

When working in inclined or vertical position and during overhead work, the machine must be secured to prevent it from falling using the safety chain (E) supplied.

- ▶ Check the safety chain for proper function before every use. A damaged safety chain must not be used. Replace a damaged safety chain immediately.

#### WARNING

- ▶ Attach the safety chain in such a way that the machine moves away from the operator in the event of slipping.
- ▶ Lay the safety chain as tightly as possible around the handle of the machine.
- ▶ Check the secure fitting of the safety chain and lock before starting work.
- ▶ Use the protective equipment stipulated in the section **“Personal protective equipment”**.

#### Work on scaffolding

#### WARNING

##### **Risk of falling from sudden oscillating movements of the machine.**

When working on scaffolding, the machine can make a sudden oscillating movement on starting or in the event of interruption to the power supply.

- ▶ Secure the machine with the safety chain (E) supplied.
- ▶ Wear a safety harness to protect yourself against falling.

## Check the condition of the substrate

The magnetic clamping force is dependent on the condition of the substrate. The clamping force is significantly reduced by paint, zinc and scale coatings and rust.

The substrate must satisfy the following conditions in order to achieve sufficient magnetic clamping force:

- The substrate must be magnetic.
- The clamping surface and the magnetic foot (14) must be clean and grease-free.
- The clamping surface must be completely smooth and level.

### NOTE

- ▶ Clean the substrate and the magnetic foot (14) of the machine before use.
- ▶ Remove any unevenness and loose rust from the substrate.
- ▶ The BDS range of accessories includes special holding devices.

The best clamping effect is obtained on low-carbon steel substrate with a thickness of at least 20 mm.

### Steel with low thickness

When drilling into low thickness steel, an additional steel plate (minimum dimensions 100 x 200 x 20 mm) must be placed under the workpiece. Secure the steel plate to prevent it from falling.

## NF metals or workpieces with an uneven surface

A special holding device must be used when drilling into NF metals or into workpieces with an uneven surface.

### NOTE

- ▶ BDS offers a range of accessories with special clamping devices for tubes and non-magnetic materials.

**Inserting the tool**

**⚠ WARNING**

**Risk of injury!**

- ▶ Do not use damaged, contaminated or worn tools.
- ▶ Change tools only when the machine is switched off and at a standstill. Pull the plug out of the mains socket.
- ▶ After inserting, check that the tool is engaged securely.
- ▶ Only use tools, adapter and accessories that match the machine.

The machine is equipped with an MK tool holder.

Depending on the type of tool to be used, corresponding drill chucks, quick-clamping systems or adapters must be used.

<b>Tool with:</b>	<b>Tool holder to be used</b>
MK3 cone	Insert directly into the spindle taper (3).
MK2 cone	Use a MK3:2 adapter sleeve and insert directly into the spindle taper (3) (available as accessory).
19 mm Weldon shaft	Use KEYLESS (A) quick-change drill chuck system
32 mm Weldon shaft	Use MK3 industrial arbor/32 mm Weldon (G).

Straight shank	Use drill chuck with MK3/B16 tapered mandrel (available as accessory).
Thread tap	Use industrial tool holder with Weldon Shank and matching adapter for drill taps (available as accessory).

**Weldon industrial tool holder (Fig. 4)**

**Inserting the tool**

- ◆ Push the MK3 industrial arbor/Weldon 32 mm (G) into the spindle taper (3) of the machine.
- ◆ Before inserting, clean the Weldon shank of the tool and the tool holder.
- ◆ Loosen both hexagonal socket screws in the tool holder (G) using the Allen wrench (H) supplied.
- ◆ Insert the tool into the tool holder (G) from below.

**NOTE**

- ▶ Insert the appropriate ejector pin (B, C, D) before inserting a core drill.

- ◆ Tighten both hexagonal socket screws in the tool holder (G) using the Allen wrench (H) supplied.

## Removing the tool

- ◆ Loosen both hexagonal socket screws in the tool mount (G) using the Allen wrench (H) supplied and remove the tool from below.

## MK tool/industrial tool holder

### Inserting the tool

- ◆ Before fitting, clean the tool shank, adapter or industrial tool holder and the spindle taper (3) of the machine.
- ◆ Insert the tool into the spindle taper (3) of the machine from below.

### NOTE

- ▶ When using tools/adapters with MK2 taper, use MK3:2 adapter sleeve.

### Removing the tool

- ◆ Turn the tool until the ejector pin (F) slips into the opening for the ejector pin (4).
- ◆ Prise out the tool with the ejector pin (F) or loosen the tool by tapping against the ejector pin.

## Using the drill chuck

### WARNING

#### Risk of injury!

An insufficiently secured tool can lead to serious injuries.

- ▶ Turn the drill chuck only with the chuck key provided.
- ▶ Always remove the chuck key from the drill chuck after tightening or loosening.

### Inserting the drill chuck

- ◆ Insert the drill chuck onto the tapered mandrel and insert the combination into the spindle taper (3) of the machine. If necessary, use an adapter sleeve.
- ◆ Open the drill chuck and insert the tool into the drill chuck.
- ◆ Close the drill chuck by hand and then turn the drill chuck with the chuck key.

### Removing the drill chuck

- ◆ Loosen the drill chuck with the chuck key and remove the tool.
- ◆ Turn the drill chuck until the ejector pin (F) slips into the opening for the ejector pin (4).
- ◆ Lever out the drill chuck with the ejector pin (F) or loosen the drill chuck by tapping against the ejector pin.

**KEYLESS quick-change drill chuck system (Fig. 3)****Inserting the tool**

- ◆ Push the KEYLESS quick-change drill chuck system (A) into the spindle taper (3) of the machine.
- ◆ Connect the lubricant line.
- ◆ Open the quick-change drill chuck system (A) by pushing up the sleeve and insert the tool into the chuck.

**NOTE**

- ▶ Insert the appropriate ejector pin before inserting the core drill.
- ▶ Turn the tool briefly to check whether the collet is engaged.

**Removing the tool**

- ◆ Open the quick-change drill chuck system (A) by pushing up the sleeve and pull the tool down out of the chuck.

**Adapter for drill taps (Fig. 5)****Inserting the tool**

- ◆ Insert the drill tap into its matching adapter.
- ◆ Insert the appropriate adapter for drill taps into the KEYLESS quick-change drill chuck system (A).

**Removing the tool**

- ◆ Open the quick-change drill chuck system (A) by pushing up the sleeve and pull the adapter for thread taps down out of the chuck system.
- ◆ Remove the drill tap by pulling it downwards out of its adapter.

## Using

### Activating/deactivating the magnetic clamp

#### Activating the magnetic clamp

##### ATTENTION

- ▶ To prevent the magnet from overheating, switch on the magnetic clamp only when the machine is standing on a magnetic substrate.
- ◆ Switch the magnet (23) ON/OFF switch on. The indicator lamp in the magnet (23) ON/OFF switch on.
- ◆ Check the magnet holding force with the magnet indicator ("MAGNET POWER" (22) indicator light).

MAGNET POWER indicator light	Magnetic holding force condition
GREEN	Sufficient magnetic holding force
RED	Insufficient magnetic holding force

##### ATTENTION

- ▶ The maximum magnetic clamping force is only available after switching on the motor.

#### Deactivating the magnetic clamp

- ◆ Hold the handle tightly (10) to stop the machine from slipping.
- ◆ Switch the magnet (23) ON/OFF switch off. The indicator lamp in the magnet (23) ON/OFF switch extinguishes.

### Switching the machine ON/OFF

- ◆ Using the ON/OFF switch (21), turn the machine ON with the green button (I) and OFF with the red button (O).

##### NOTE

- ▶ The machine can only be switched on when the magnetic clamp has been switched on.
- ▶ Allow a severely overheated machine to run on at idle speed for approx. 2 minutes.
- ▶ The machine switches off automatically in the event of a power failure or if the magnetic clamp is switched off.

### Selecting the speed range

##### ATTENTION

- ▶ Switch the gear stages only with the machine at standstill.

##### NOTE

- ▶ Select the speed range according to the material and drilling diameter.

The machine has a gearbox with four mechanical gear stages: The gear stage is selected by means of the two selector levers (5) on the side of the gearbox.



- ◆ To select the desired gear stage, switch the machine off and set both selector levers (5) to the desired speed as shown in the table below.

Gear level	max. speed	Selector lever	
		left	right
Level 1	110 rpm	●	●●
Level 2	175 rpm	●	●
Level 3	370 rpm	●●	●●
Level 4	600 rpm	●●	●

### Setting the speed

In addition to the mechanical gearbox, the machine is also equipped with full-wave control electronics for stepless variable speed adjustment.

- ◆ First set the appropriate gear stage, then adapt the speed using the electronic speed control (31).

Gear stage	Speed range
Level 1	40 - 110 min <sup>-1</sup>
Level 2	65 - 175 min <sup>-1</sup>
Level 3	140 - 370 min <sup>-1</sup>
Level 4	220 - 600 min <sup>-1</sup>

### NOTE

- ▶ If possible, always select a setting with low gear stage and high motor speed. The motor is then set with a higher torque and therefore protected against overheating under heavy load.

### Setting the torque cut-off

#### ATTENTION

- ▶ Do not use this function to switch off the machine when cutting threads in blind holes.

In order to protect the tool, the maximum torque of the machine can be set using the controller (32).

When the maximum set torque is reached, the machine switches off. After the cut-out, the machine must be switched off and then on again at the ON/OFF switch (21).

**Rotating mechanism (MAB 845 only):**

In order to permit optimum alignment even in difficult positions, the model MAB 845 is additionally equipped with a rotating mechanism. It allows the upper part of the machine to be rotated by 30° to both sides and by 20 mm forwards and backwards with the magnetic foot engaged.

- ◆ Loosen the locking device of the rotating mechanism (13).
- ◆ Position the upper part of the machine laterally and longitudinally.
- ◆ Lock the rotating mechanism again.

**ATTENTION**

- ▶ Operate the machine only with the rotating mechanism locked.

**Drilling with the machine****Drilling with twist drills**

When drilling with twist drills, proceed as follows:

- ◆ Push twist drills with MK taper into the spindle taper (3) of the machine from below.
- ◆ Push twist drills with straight shank into the drill chuck after fitting the drill chuck (see section **“Using the drill chuck”**).
- ◆ Position and fix the machine at the location of use.
- ◆ Switch on the clamping magnet and check the magnetic holding force (see section **“Activating/deactivating the magnetic clamp”**).
- ◆ Select a suitable speed and switch on the machine.
- ◆ Direct the drill to the material with the handle (11).

**NOTE**

Observe the following instructions when drilling with twist drills:

- ▶ Under excessive pressure, the drill can wear out and the machine can be overloaded.
- ▶ Make sure that swarf is removed regularly. With larger drilling depths, break up the swarf.

### Drilling with core drills

When drilling with core drills, proceed as follows:

- ◆ For core drills with 19 mm Weldon shank, install the quick-change drill chuck system (A)..
- ◆ For core drills with 32 mm Weldon shank, install the industrial arbor (G).
- ◆ Connect the cooling lubricant system.
- ◆ Insert the appropriate ejector pin into the core drill and insert the core drill into the tool holder.
- ◆ Position and fix the machine at the location of use.
- ◆ Switch on the clamping magnet and check the magnetic holding force (see section “**Activating/deactivating the magnetic clamp**”).
- ◆ Select a suitable speed and switch on the machine.
- ◆ Direct the drill to the material with the handle (11).

#### NOTE

Observe the following instructions when drilling with core drills:

- ▶ Drilling with core drills does not require great force. The drilling process is not accelerated by higher pressure. The drill wears faster and the machine can be overloaded.
- ▶ Use the high-performance BDS 5000 cutting oil in the cooling lubricant system of the machine.
- ▶ The cooling lubricant system cannot be used when working overhead. In this case, use the high-performance ZHS 400 grease spray. Spray the drill on the inside and outside before drilling. In the case of larger drill depths, repeat this procedure.
- ▶ Make sure that swarf is removed regularly. With larger drilling depths, break up the swarf.

### Thread cutting

The machine is equipped with reversible direction of rotation and can also be used for cutting threads.

In order to cut threads, proceed as follows:

- ◆ Drill the hole for the thread.
- ◆ Switch off the machine and set the lowest gear stage and speed.

- ◆ Set the direction of rotation to clockwise (R) at the switch (24).
- ◆ Tighten the drill tap in the machine using the appropriate drill tap adapter.
- ◆ Switch on the machine and place the drill tap onto the drilled hole.
- ◆ Use the hand lever (11) without exerting pressure to guide the machine until the desired thread length has been cut.
- ◆ Switch off the machine and set the direction of rotation to anti-clockwise (left = L) at switch (24).
- ◆ Switch on the machine again and allow the drill tap to completely emerge out of the workpiece. Then use the hand lever (11) to guide the machine slide upwards in order to avoid damaging the top of the thread.

## Reaming/counter-sinking

Thanks to its wide range of operating speeds, the machine can also be used for reaming or counter-sinking.

### ATTENTION

- ▶ When reaming and counter-sinking, observe the limits stated in the technical data for the tools to be used.

## Eliminating blockages

### WARNING

**Danger of cut injuries from broken tool parts or swarf.**

- ▶ Put protective gloves on before starting work.

### **Blockages caused by a broken tool:**

- ◆ Switch off the machine. Remove plug from the mains socket.
- ◆ Move the machine slide to the upper position with the help of the hand lever (11).
- ◆ Replace defective tool. Remove swarf.

### **Other blockages:**

- ◆ Switch the machine off using the motor switch. Leave the magnetic clamp switched on.
- ◆ Move the machine slide to the upper position with the help of the hand lever (11).
- ◆ Remove swarf and check tool.

### NOTE

- ▶ The BDS range of accessories includes special devices (e.g., POW 200) for removing swarf.

## Cleaning/maintenance

### ⚠ WARNING

- ▶ Switch off the machine and disconnect the voltage supply before performing maintenance or cleaning (Pull the plug out of the mains socket.).
- ▶ When using compressed air for cleaning, wear protective goggles and gloves and protect other persons in the working area.

### ATTENTION

- ▶ Never immerse the machine in water or other liquids.

## Cleaning

### After each use

- ◆ Remove the inserted tool.
- ◆ Remove swarf and coolant residues.
- ◆ Clean the tool and the tool holder on the machine.
- ◆ Clean the guide of the machine slide.
- ◆ Put the machine and accessories into the transport case.

## Maintenance

### ⚠ WARNING

#### **Danger caused by unqualified repairs!**

Unqualified repairs can lead to considerable danger for the user and cause damage to the machine.

- ▶ Repairs to electrical appliances may only be carried out by the works customer service or by specialists trained by the manufacturer.

### Adjusting the machine slide guide

If the machine slide guide (15) exhibits too much clearance, it must be adjusted. To do this, proceed as follows:

- ◆ Loosen the clamping bolts.
- ◆ Tighten the adjusting screws evenly.
- ◆ Tighten the clamping bolts again.

### Replacing the carbon brushes

Replacement of the carbon brushes may only be carried out by BDS or by an authorised specialist workshop. Unauthorised repairs will invalidate the guarantee.

## Customer service/service

Should you have any questions on customer service/service, please contact BDS. We will be happy to give you the address of your nearest service partner.

## Storage

If you do not intend to use the machine for a longer period of time, clean it as described in the section **“Cleaning”**. Store the machine and all its accessories in the transport case at a dry, clean and frost-free location.

## Troubleshooting

Error	Possible cause	Remedy
The motor does not start after pressing the ON/OFF switch or stops during operation.	Plug not inserted into socket.	Insert plug.
	Circuit breaker switched off.	Switch on circuit breaker.
	The magnetic clamp is not switched on.	Switch on the magnetic clamp.
	Direction of rotation not selected.	Select direction of rotation.
	The internal safety switch has switched off the machine due to overheating.	Allow the machine to cool down.
	The torque cut-off was triggered.	Switch the machine off and on again.
The circuit breaker in the power distributor trips.	Too many appliances connected to the same power circuit.	Reduce the number of appliances on the power circuit.
	The machine is defective.	Contact customer service.
The magnetic clamp does not function.	Magnet not switched on.	Switch on the magnet.
	The surface is not magnetic.	Use a suitable base.
The lubrication system does not function.	No lubricant available.	Top up the lubricant.
	Lubricant tap closed.	Open the lubricant tap.
	Connecting nipple clogged.	Clean the tank and nipple.

### NOTE

- ▶ If you cannot resolve the problem with the steps described above, please contact customer service.

**Technical data**

<b>Model</b>	<b>MAB 825/845</b>	
Dimensions (L x W x H)	366 x 239 x 725	mm
Magnetic foot (L x W)	220 x 110	mm
Approx. net weight.	25	kg
Operating voltage (see type plate)	230 V / 50-60 Hz or 110-125 / 50-60 Hz	
Power consumption	1800	W
Noise emission	89	db(A)
Vibration	0.77	m/s <sup>2</sup>
Stroke	255	mm
<u>Core drill:</u>		
■ short Ø	12 - 100	mm
■ long Ø	12 - 100	mm
<u>Twist drill:</u>		
■ max. Ø	31.75	mm
Thread max. Ø	M30	
Reaming max. Ø	31.75	mm
Counter-sinking max. Ø	50	mm
Speed stage 1	n <sub>0</sub> = 40 - 110	rpm
Speed stage 2	n <sub>0</sub> = 65 - 175	rpm
Speed stage 3	n <sub>0</sub> = 140 - 360	rpm
Speed stage 4	n <sub>0</sub> = 220 - 600	rpm
Thermal protection	Yes	
Slip clutch	Yes	
Variable torque	Yes	
Full-wave control electronics	Yes	
Clockwise/anticlockwise rotation	Yes	
Spindle taper	MK3	
Core drill assembly	KEYLESS MK 3/19 (3/4") Weldon MK3/32 mm industrial holder	
Connecting cable length	4	m
Protection class	I	
Protection type	IP20	

## EC Declaration of Conformity

<b>in accordance with Machine Directive 2006/42/EC, appendix II 1A</b>	
Name/address of the manufacturer:	<b>BDS Maschinen GmbH</b> Martinstraße 108 D-41063 Mönchengladbach
We hereby declare that the product:	
Model:	<b>Magnetic core drilling machine</b>
Model	<b>MAB 825/845</b>
conforms to the following relevant regulations: <ul style="list-style-type: none"> <li>■ <b>EC Directive 2006/42/EC on machinery</b></li> </ul>	
The following harmonised standards were applied in whole or in part: <ul style="list-style-type: none"> <li>● DIN EN ISO 12100:2011-03</li> <li>● DIN EN 62841-1:2016-07</li> </ul>	
Authorised person for compiling the technical documentation:	<b>BDS Maschinen GmbH</b>
Full technical documentation is available. The operating instructions associated with the product is available.	
It is required that the product is only operated as intended. Information on operating as intended can be obtained from the technical documentation.	
Mönchengladbach, 01st August, 2016	 Wolfgang Schroeder, Technical Director _____ (Legally binding signature of the issuer)



**Fig. 3**



**Fig. 4**



**Fig. 5**



**A**



**B, C, D**



**E**



**F**



**G**



**H**

**BDS Maschinen GmbH**  
Martinstraße 108  
D-41063 Mönchengladbach

Fon: +49 (0) 2161 / 3546-0  
Fax: +49 (0) 2161 / 3546-90

Internet: [www.bds-maschinen.de](http://www.bds-maschinen.de)  
E-mail: [info@bds-maschinen.de](mailto:info@bds-maschinen.de)

**Galex**  
DISTRIBUTION ■ ■

8 rue Nicolas Appert  
56520 Guidel / France

02 98 96 73 95  
[contact@galexdistribution.com](mailto:contact@galexdistribution.com)

---